



FS-780

Tag: _____

12" Square x 6" Deep Stainless Steel Sanitary Floor Sink

SPECIFICATION: Watts Drainage FS-780 12" (305) square x 6" (152) deep 14 ga. type 304 stainless steel sanitary floor sink with loose set cast stainless steel grate, dome bottom strainer, and no hub (standard) outlet.

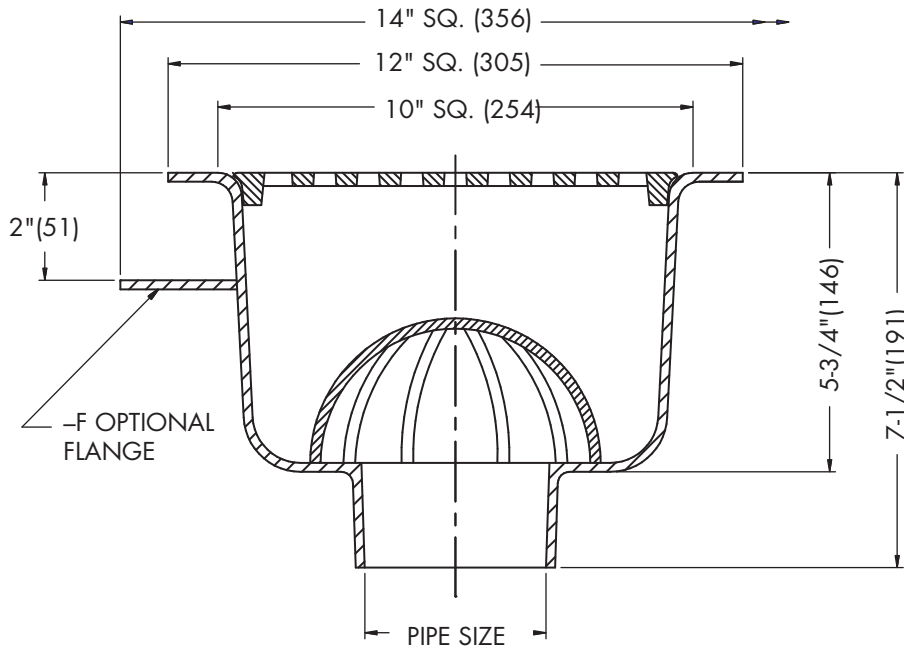

Pipe Sizing (Select One)	
Suffix	Description
2	2"(51) Pipe Size <input type="checkbox"/>
3	3"(76) Pipe Size <input type="checkbox"/>
4	4"(102) Pipe Size <input type="checkbox"/>

Outlet Type (Select One)	
Suffix	Description
NH	No Hub (MJ) <input type="checkbox"/>
P	Push On <input type="checkbox"/>

Options (Select One or More)	
Suffix	Description
-F	Flange with Weepholes <input type="checkbox"/>
-FC	Flange w/Weepholes & Flashing Clamp <input type="checkbox"/>
-5	Sediment Bucket <input type="checkbox"/>
-6	Vandal Proof <input type="checkbox"/>
-21	Secondary Strainer <input type="checkbox"/>
-33	Less Grate <input type="checkbox"/>
-150	1/2 Grate <input type="checkbox"/>
-175	3/4 Grate <input type="checkbox"/>
-F4-1	4" Round Nickel Bronze Funnel <input type="checkbox"/>
-F4-3	4" Round SS Funnel <input type="checkbox"/>
-F6-1	6" Round Nickel Bronze Funnel <input type="checkbox"/>
-G-1	4x9" Oval Nickel Bronze Funnel <input type="checkbox"/>
-G-3	4x9" Oval SS Funnel <input type="checkbox"/>
-HD	Heavy Duty Top Assembly <input type="checkbox"/>

Free Area Sq. In.	Free Area Sq. In.
21	47

w/-HD Top Assy.

NOTICE

The information contained herein is not intended to replace the full product installation and safety information available or the experience of a trained product installer. You are required to thoroughly read all installation instructions and product safety information before beginning the installation of this product

Job Name _____

Job Location _____

Engineer _____

Contractor _____

Contractor's P.O. No. _____

Representative _____

Watts product specifications in U.S. customary units and metric are approximate and are provided for reference only. For precise measurements, please contact Watts Technical Service. Watts reserves the right to change or modify product design, construction, specifications, or materials without prior notice and without incurring any obligation to make such changes and modifications on Watts products previously or subsequently sold.

USA: Tel: (800) 338-2581 • Fax: (828) 248-3929 • Watts.com
Canada: Tel: (905) 332-4090 • Fax: (905) 332-7068 • Watts.ca
Latin America: Tel: (52) 81-1001-8600 • Fax: (52) 81-8000-7091 • Watts.com



A Watts Water Technologies Company