

Engineering Specification

Job Name _____

Contractor Signature _____

Orion Representative _____

Approval Date _____

Quantity Required _____

Contractor's P.O. No. _____

ARLS-14

Single Bowl 18" x 12" x 8" Sink With Offset 1-1/2" Outlet

Specification

Orion Polyolefin ARLS-14 Lab Sink is manufactured from virgin high density polyethylene conforming to ASTM F 1412. It features an integral threaded outlet located in the rear corner of the sink.

Features

- Integral offset waste outlet
- Impact resistant & glassware friendly
- Dry ice tolerable
- Coved corners for easy clean up
- Flush mount & under-counter mount rims available
- Dimensions are inches +/- .125
- Weight: 106 oz

Mounting Options:

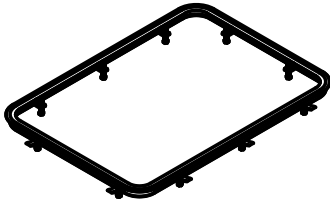

Mounting Rim

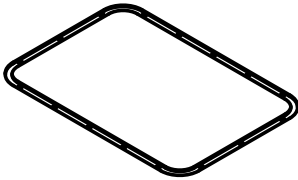

Under-counter Mounting Rim

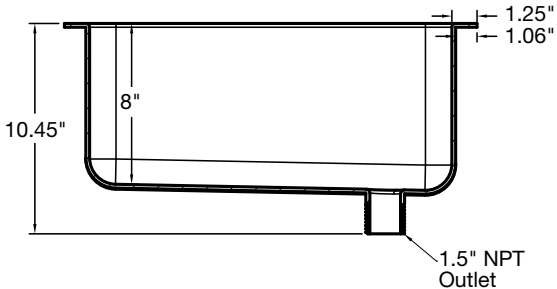
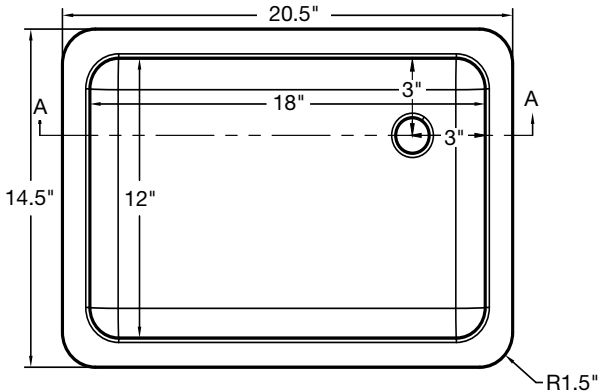

Call customer service if you need assistance with technical details.

Qty.	Order Code	Description
	737110	ARLS-14 Lab Sink
	737005	ARLS-14 Mounting Rim
	737000	Under-counter Univ Mounting Rim

NOTICE

The information contained herein is not intended to replace the full product installation and safety information available or the experience of a trained product installer. You are required to thoroughly read all installation instructions and product safety information before beginning the installation of this product.

Orion product specifications in U.S. customary units and metric are approximate and are provided for reference only. For precise measurements, please contact Orion Technical Service. Orion reserves the right to change or modify product design, construction, specifications, or materials without prior notice and without incurring any obligation to make such changes and modifications on Orion products previously or subsequently sold.



USA: T: (800) 334-6259 • OrionFittings.com
 Canada: T: (888) 208-8927 • OrionFittings.ca
 Latin America: T: (52) 55-4122-0138 • OrionFittings.com
 ES-OR-ARLS-14 2538

A WATTS Brand